

V1-KS

RF DIM

Rotary LED Dimmer

- Single channel constant voltage LED Rotary dimmer.
- Match with RF 2.4G single zone or multiple zone dimming remote control optional.
- 0-100% dimming smoothly without any flash.
- Logarithmic or linear dimming curve selectable.
- PWM frequency 500Hz, 2KHz, 8KHz or 16KHz selectable.
- Over-heat / Short circuit / Reverse protection, recover automatically.
- Light on/off fade time 3s selectable.



CE RoHS emc

Technical Parameters

Input and Output		Dimming data		Safety and EMC	
Input voltage	12-48VDC	Input signal	Rotary knob + RF 2.4GHz	EMC standard (EMC)	ETSI EN 301 489-1 V2.2.3 ETSI EN 301 489-17 V3.2.4
Input current	8.5A	Control distance	30m(Barrier-free space)	Safety standard	EN 62368-1:2020+A11:2020
Output voltage	12-48VDC	Dimming gray scale	256levels	Radio Equipment(REL)	ETSI EN 300 328 V2.2.2
Output current	8A@12-24V 6A@36-48V	Dimming range	0 - 100%	Certification	CE,EMC
Output power	96W@12V 192W@24V 216W@36V 288W@48V	Dimming curve	Logarithmic or linear	Environment	
Output type	Constant voltage	PWM Frequency	500Hz, 2KHz, 8KHz, 16KHz	Operation temperature	Ta: -20°C ~ +55°C
Warranty		Package		Case temperature (Max.)	Tc: +85°C
Warranty	5 years	Size	L70xW60xH40mm	IP rating	IP20
		Gross weight	0.059kg		

Mechanical Structures and Installations

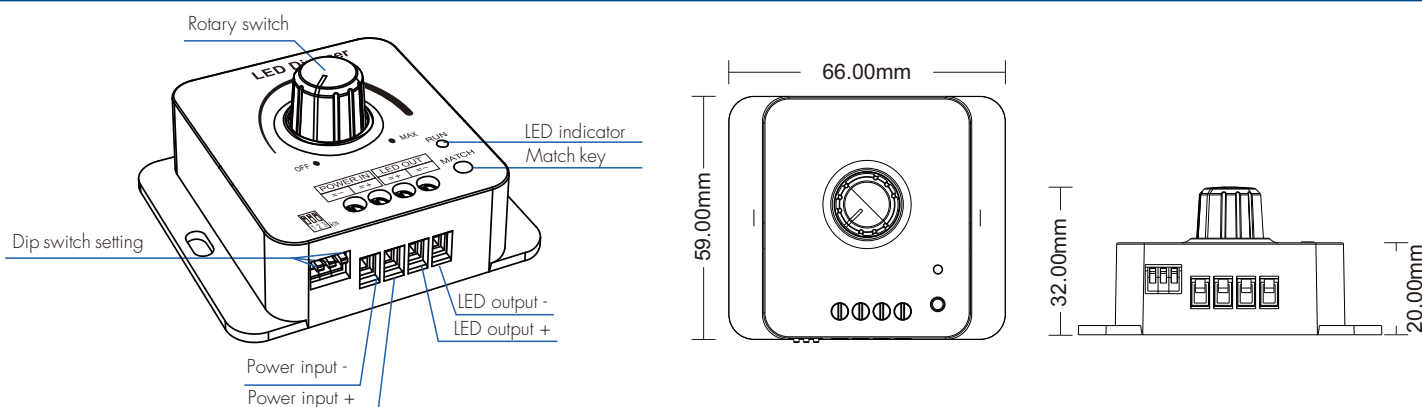

Wiring Diagram

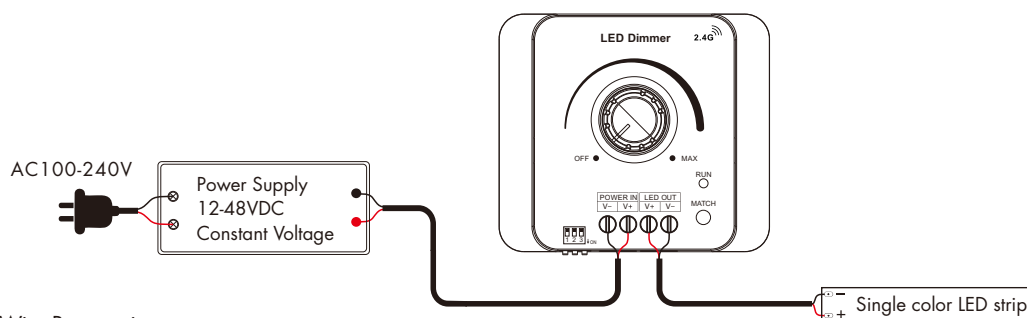



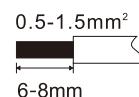

Wire Preparation:

1. The wiring can be solid or stranded with a cross-sectional area of 0.5 to 1.5 mm². Conventional 1mm² can withstand 10A output current.
2. When wiring is installed, the terminals must be tightened. If they are not tightened, the contact point resistance will be too high and the terminals will easily burn due to heat when used at full load for a long time.



Note: The output power of a constant voltage power supply should be at least 1.2 times that of the output load (light strip), otherwise the full power output of the load can easily cause automatic flickering or shaking of the light.

PWM frequency setting

			
500Hz	2KHz	8KHz	16KHz
8A	8A	6A	4A (12-24V)
6A	6A	4A	3A (36-48V)

We can select four PWM frequency: 500Hz, 2kHz, 8kHz or 16kHz.
Higher PWM frequency, will cause lower output current, higher power noise,
but more suitable for camera(No flickers for video).

Dimming curve setting

Logarithmic dimming curve

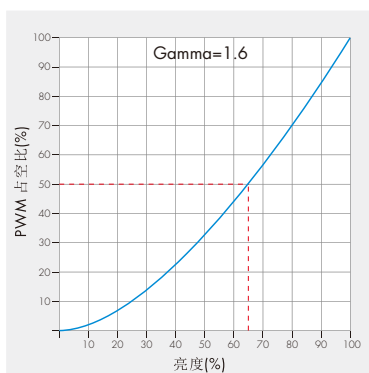

Linear dimming curve

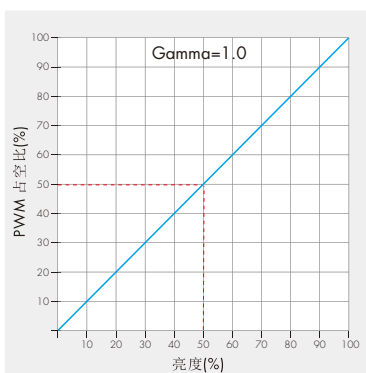

Match Remote Control (two match ways)

User can choose the suitable match/delete ways. Two options are offered for selection:

Use Match key

Match:

Short press match key, immediately press on/off key (single zone remote) or zone key (multiple zone remote) on the remote.

The LED indicator fast flash a few times means match is successful.

Delete:

Press and hold match key for 5s to delete all match,

The LED indicator fast flash a few times means all matched remotes were deleted.

Use Power Restart

Match:

Switch off the power, then switch on power, repeat again.

Immediately short press on/off key (single zone remote) or zone key (multiple zone remote) 3 times on the remote.

The light blinks 3 times means match is successful.

Delete:

Switch off the power, then switch on power, repeat again.

Immediately short press on/off key (single zone remote) or zone key (multiple zone remote) 5 times on the remote.

The light blinks 5 times means all matched remotes were deleted.

Light on/off fade time

When using the RF remote control to turn the lights on and off, you can set a 3s light on/off fade.

Long press match key 5s, then short press match key 3 times, the light on/off time will be set to 3s, the indicator light blink 3 times.

Long press match key 10s, restore factory default parameter, the light on/off time also restore to 0.5s.

Malfunctions Analysis & Troubleshooting

Malfunctions	Causes	Troubleshooting
No light	<ol style="list-style-type: none"> No power. Wrong connection or insecure. 	<ol style="list-style-type: none"> Check the power. Check the connection.
No response from the remote	<ol style="list-style-type: none"> The battery has no power. Beyond controllable distance. The controller did not match the remote. 	<ol style="list-style-type: none"> Replace battery. Reduce remote distance. Re-match the remote.

Installation Precautions

- The distance between the products should be $\geq 20\text{cm}$, so as not to affect lifespan of the products due to poor heat dissipation.
- The product shall not be installed close to the switching power supply with an interval of $\geq 20\text{cm}$ to avoid radiation interference of the switching power supply.
- The installation height shall be $\geq 1\text{m}$ from the floor to avoid shortening the remote control distance due to too weak reception signal.
- The products are not allowed to be close to or covered by metal objects, with an interval of $\geq 20\text{cm}$ to avoid signal attenuation and shorten the remote distance.
- Avoid installation at the corner of the wall or the corner of the beam, with an interval of $\geq 20\text{cm}$ to avoid signal interference.