

Specification

Integrated Furniture Lighting

LE1212



LE1212

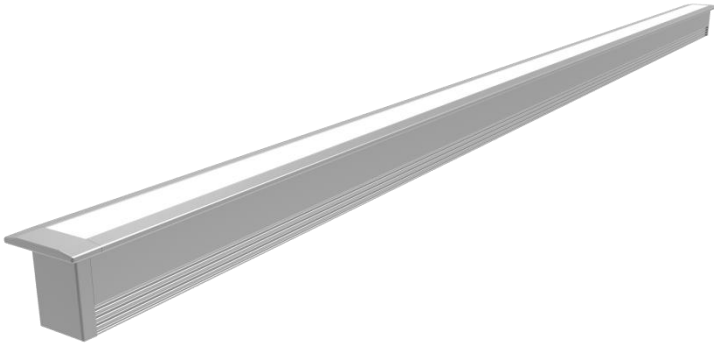

Example of application: wooden decorative board on the wall

Cutout:W10*D12mm fixed by glass cement



Features

DLS1.0, a special local auxiliary lighting system, can be widely used in various interior decoration scenarios and local light spaces. A touch of auxiliary decorative lighting in addition to the basic lighting creates different atmospheres and visual enjoyment.

Embellish life with light that follows you whenever you go.

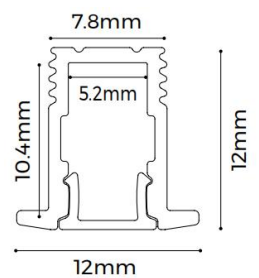

- 1、 “Dots-free”lighting
Perfect homogenous lighting.
- 2、 Various diffuser options
Several options of diffusers, In various shapes and light distribution plans Complete with everything needed
- 3、 “Two” end caps
Two options of end cap for two ways of wire outgoing, Close-fitting design without screws makes installation much easier
- 4、 Various installation methods
A wide range of installation accessories wider applications
- 5、 “One” cut.
Consistent length between diffuser and profile
- 6、 Smart control for unlimited possibilities
Perfectly match the profiles like customized, Control by hand sweep or touching

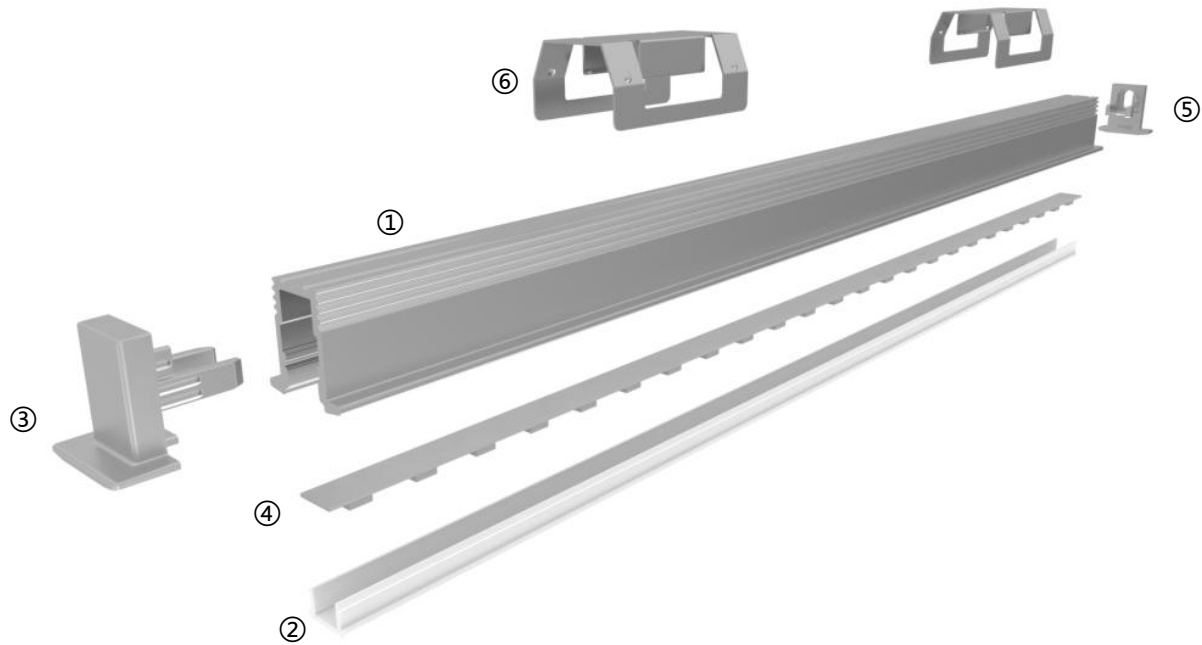

Details







Standard Configuration

Picture	Item	Parameter	Model
	① Profile	Material: AL6063-T5 Profile weight: 0.23kg/2.5m Size: L2500*W12*H12mm Surface processing: Anodizing	/
	② Cover	Type: Frosted diffuser Material: PC Light transmittance: 55% Size: L2500*W6.4*H3.7mm (shrink) 0.8mm/m when the temperature rises (drops) 10°C.	/
	③ End caps	Size: L12*W12*H10mm	EC-LE1212



Optional Accessories

Picture	Item	Parameter	Model
	② Black Cover	Type: Black diffuser Material: PC Light transmittance: 15% Size: L2500*W6.4*H3.7mm (shrink) 0.8mm/m when the temperature rises (drops) 10°C.	CV-LR0812
	④ FPC strip D6140-24V-4mm	Material: FPC, CCT: 2700/3000/4000/6000K; Ra > 90; Voltage:24V; Power: 6.6W/m; Lumen: 710Lm/m; PCB width: 4mm; Minimum cut: 50mm;	D6140-24V-4mm
	⑤ End caps	Size: L12*W12*H10mm	EC-LE1212
	⑥ Recessed clips	Size: L25*W13*H9.5mm	CP-11

Optical Parameter

The testing result of 1M luminaire (with "D6140-24V-4mm" and diffuser)

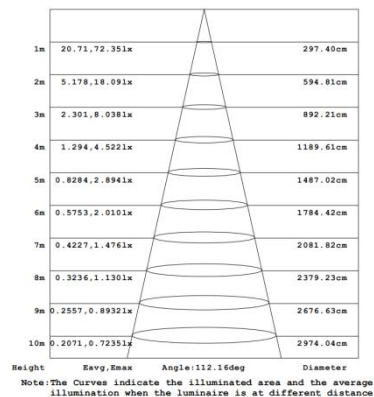
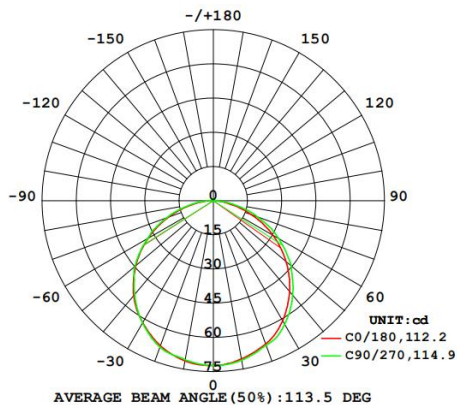

Package

Mode 1 :

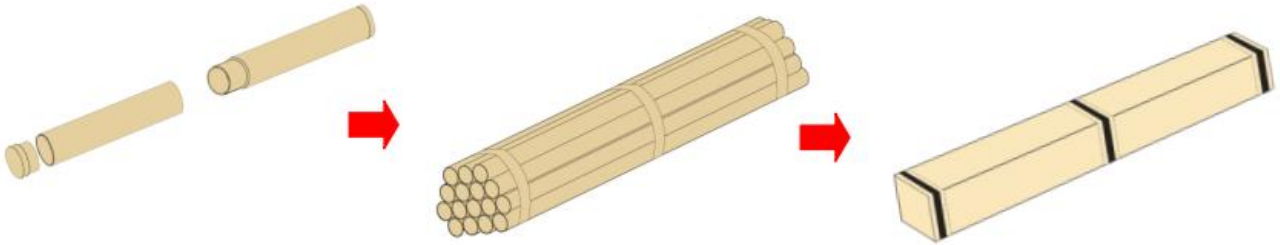

Mode 2 :

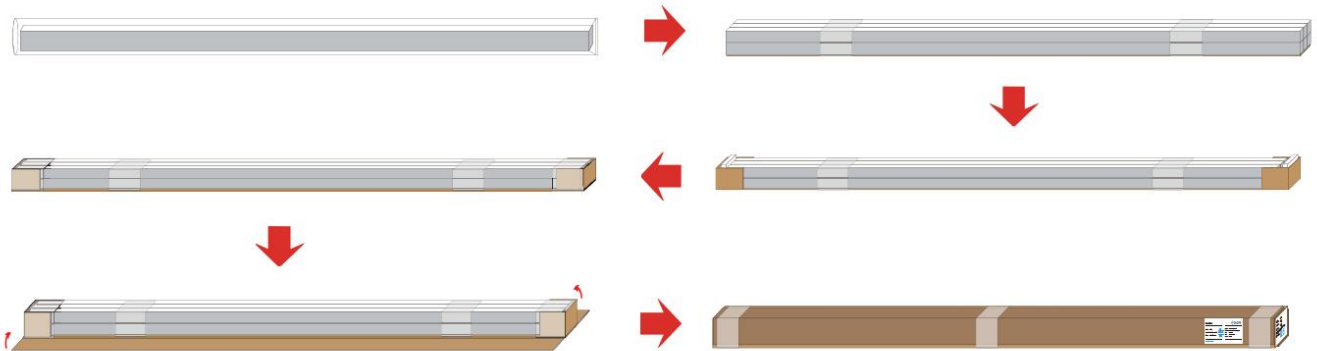

Components	Packaging material	Size(mm)	NW(kg)	GW(kg)	Content
Single piece	Hat box	Φ22mm*2580mm	0.24	0.51	1pcs/box
Whole bundle	Hat box	2580*250*165mm	15.12	34.13	63pcs/box
Whole box packaging	Paper box	2580*95*100mm	5.76	8.76	24pcs/box

