

XENO LED MODULE 150/90°

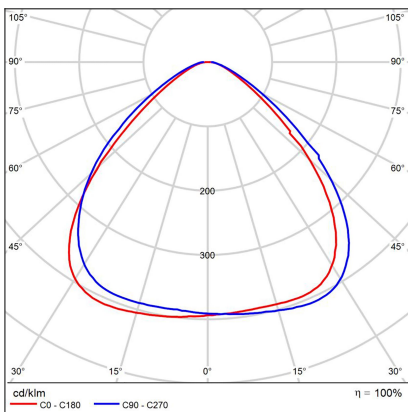
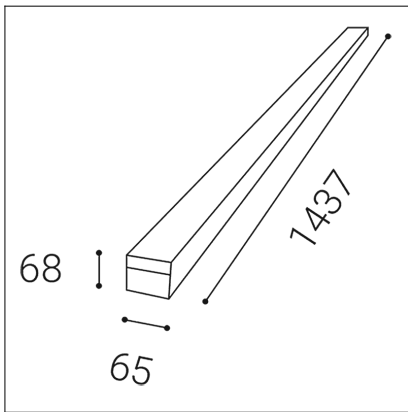

Code: 6350141D
Color: WHITE / 9003
Material: METAL
Power: 25-75W
Color temperature: 4000K
Lumen output: 12000lm
Efficacy: 160lm/W
Color rendering index: 80+
SDCM: < 3
Light beam angle: 90°
Light Source: LED
Dimmable: DALI/PUSH
LED lifetime: L80B20 90.000h
Driver: 100-450 mA
Voltage / Frequency: 220-240V/50-60Hz
Emergency: NO
Dimensions luminaire: 1437x65x23 mm
Product weight kg: 1,85 kg
Packing carton: 8
Package dimensions: 65x50x1440 mm

SK

Systém lineárnych, modulárnych svietidiel, spájateľný do zostáv. V prevedení s 2 rôznymi optikami, štandardne v stmievateľnej verzii. K dispozícii sú spojky, závesy, napájanie a ďalšie komponenty. Vyrobené z kovu. K dispozícii v bielej farbe. Použitie - predajne, showroomy, obchodné priestory, sklady, výrobné priestory.

CZ

Systém lineárních, modulárních svítidel, spojitelných do sestav. V provedení se 2 různými optikami, standardně ve stmívatelné verzi. K dispozici jsou spojky, závěsy, napájení a další komponenty. Vyrobeno z kovu. K dispozici v bílé barvě. Použití - prodejny, showroomy, obchodní prostory, sklady, výrobní prostory.

EN

A system of linear, modular lighting fixtures that can be connected into assemblies. In a design with 2 different optics, as standard in a dimmable version. Connectors, hinges, power supply and other components are available. Made of metal. Available in white. Use - stores, showrooms, business premises, warehouses, production premises.

DE

Ein System von linearen, modularen Leuchten, die zu Baugruppen verbunden werden können. In einem Design mit 2 verschiedenen Optiken, standardmäßig in einer dimmbaren Version. Verbinder, Scharniere, Netzteil und andere Komponenten sind verfügbar. Aus Metall. Erhältlich in weiß. Verwenden - Geschäfte, Ausstellungsräume, Geschäftsräume, Lager, Produktionsstätten.

