

1. Features



- Ultra-slim design for Tri-proof LED light
- Patented antenna design makes reliable detecting, avoid missing triggered when sensor built-in backside of metal LED plate.
- Adjustable detecting sensitivity via DIP switches, suitable to variety of installation sites.
- Support 6m Max. Mounting height .
- 5 years warranty

2. Parameter

Input	Operating Voltage Range	198-264V AC, 50Hz/60Hz
	Rated Voltage	220-240V AC, 50Hz/60Hz
	Stand-by Power	≤0.5W
	Surge Test	L--N: 1kV
Output	Working Mode	ON/OFF function
	Type of Load	Inductive or Resistive
	Load Capacity	400W(Inductive) ; 800W(Resistive)
	Max. Surge Capacity	30A (50% I _{peak} , t _{width} =500uS, 230Vac full load, cold start); 60A (50% I _{peak} , t _{width} =200uS, 230Vac, full load, cold start)
Sensor Parameters	Operating Frequency	5.8 GHz ±75 MHz, ISM Band.
	Transmitting power	0.5mW Max.
	Hold time	5s//30s/90s/5min/20min/30min
	Detection Sensitivity	100%/75%/50%/25%
	Daylight Sensor	2Lux/10Lux/30Lux/50Lux/Disable
	Detecting Radius	3-10m (mounting height 3-4m) 2-8m(mounting height 6m)
	Mounting Height	6m Max.
	Detecting Angle	150° (Wall mounted), 360° (Ceiling mounted)
Operating Environment	Operating Temperature	-25°C...+60°C
	Storage Temperature	-40°C...+80°C(Humidity: 10%-95% Non-condensing)
Certificate Standards	Safety standards	EN61058-1
	EMC standards	EN300440; EN301489-1; EN55015; EN61547; EN61000-3-2; EN61000-3-3; EN62479
	Environmental Requirement	Compliant to RoHS
	Certificate	CE, RED

Others	Wiring	Press-in Type Terminals, wire diameter: 0.75-1.5mm ²
	IP Rating	IP20
	Protection Class	Class II
	Installation	Built-in
	Dimension	77.5*34.5*22mm
	Package	Bubble bag+Clapboard + Carton (K=A)
	Net Weight	58±2g
	Lifetime	5 years warranty @Ta 230V full load

Note

1. "N/A" means not available.
2. Detection area is effected on volume of motion object and motion speed. The detection area is tested by a 170cm height person and walking speed is 0.3m/s.

3. Function

On/OFF Function

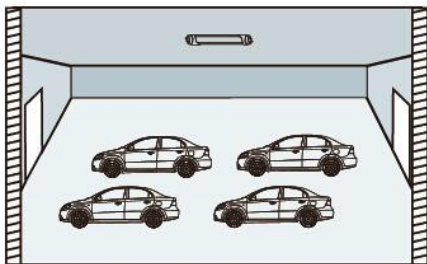

- 1 With sufficient ambient light, the light will not be switched on even if with motion signal.

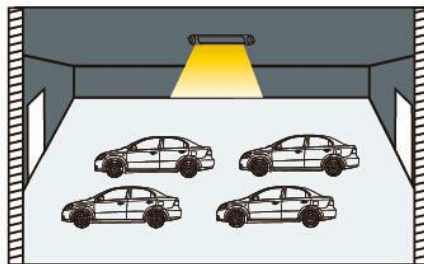

- 2 With insufficient ambient light, the sensor switches on the light when motion is detected.



- 3 After elapse of hold time, the sensor switches off the light when no motion is detected.

4. Dimension (mm)

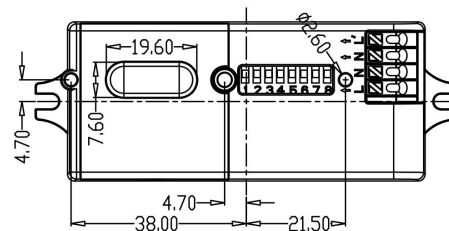
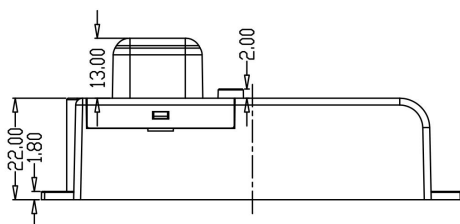
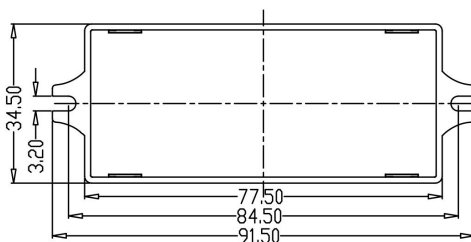

5. Wiring

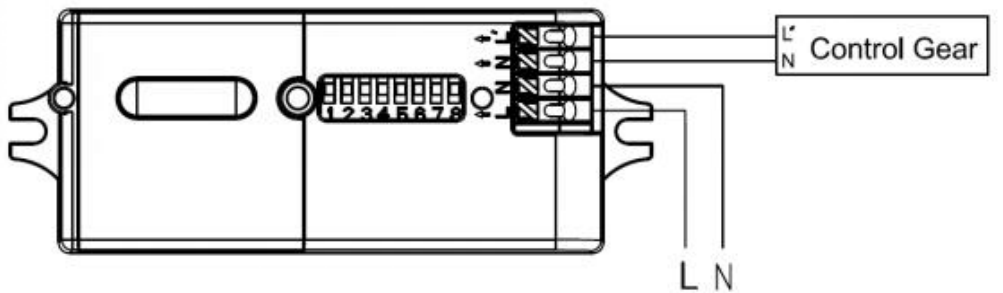

*The sensor is designed for connect one load only. Connect more than one loads may damage the sensor.

6. Structure

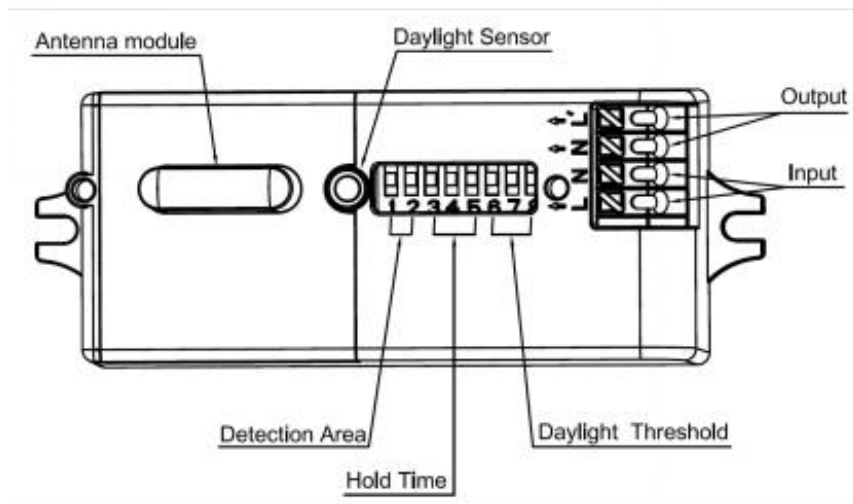

7. Radiation Pattern

1) Ceiling mounting

Ceiling mounted height: 3m
Sensitivity: 100%/75%/50%/25%

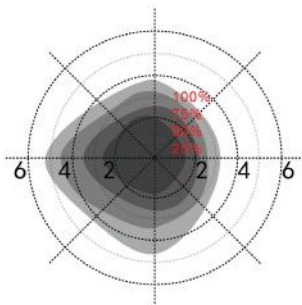

Normal moving (Speed:1m/s)

Ceiling mounted height: 6m(*)
Sensitivity:100%/75%

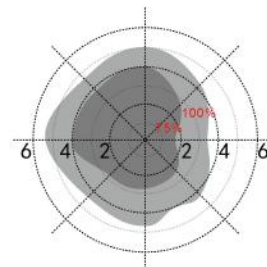

Normal moving (Speed:1m/s)

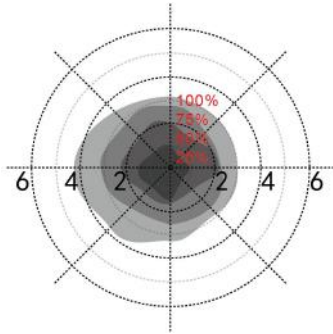

Slow moving (Speed 0.3m/s)

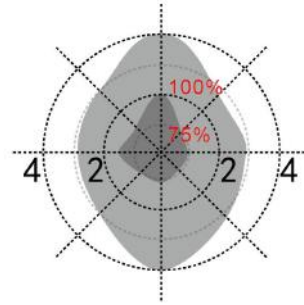

Slow moving (Speed: 0.3m/s)

*Only 100%/75% detection sensitivity is workable when installed at 6m mounting height. 25%/50% sensitivity is not able to detect motion signal.

2) Wall mounting

Horizon mounted height: 2m
Sensitivity: 100%

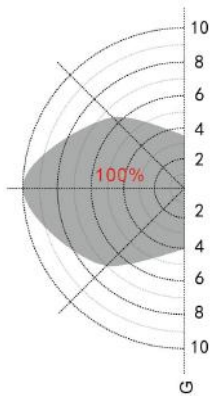

Normal moving (Speed: 1m/s)

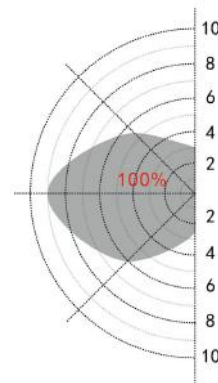

Slow moving (Speed 0.3m/s)

8. DIP Switch Setting

Detection Area (Sensitivity)

	1	2
100%	ON	ON
75%	-	ON
50%	ON	-
25%	-	-

Hold Time

	3	4	5	
I	ON	ON	ON	5S
II	-	ON	ON	30S
III	ON	-	ON	90S
IV	-	-	ON	5min
V	ON	ON	-	20min
VI	-	-	-	30min

Daylight Threshold

	6	7	8	
I	ON	ON	ON	2Lux
II	ON	ON	-	10Lux
III	-	ON	-	30Lux
IV	ON	-	-	50Lux
V	-	-	-	Disable*

*Disable” means the daylight sensor not work. it will turn on light once motion is detected regardless of ambient light .

9. Override Function

After initialization,Continuously switch ON/OFF 3 times to override sensor function. 2s for each on/off switch .Lights keep on all the time.

Power off and on again to recover sensor function. 2s for each On/Off switch .

10. Initialization

After power on, the sensor automatically turns on light at 100% brightness. After 10sec, it turns off the light. During the initialization, the sensor is not able to detect movement.

11. Factory Setting

Detection area: 100%, Hold Time: 5S, Daylight Sensor: Disable

12. Application Notice

- 1) The sensor should be installed by a professional electrician. Please turn off the power before installing, wiring, changing the setting of the DIP switch.
- 2) The sensor which installed in the plastic and glass lampshade will reduce the sensitivity. For every 3mm increase in thickness, the sensitivity will be reduced by 20%.
- 3) The light sensitivity threshold is in a sunny environment, no shadow and ambient light diffuse reflection. Ambient lux level will be different in different environment, weather, climate, time-of-day and season.
- 4) The parameters of the sensor may need to be reconfigured in different installation environments.
- 5) This sensor is for indoor use only. It will affect the waterproof effect for outdoor use. Wind, rain, and moving objects around will cause false triggering.
- 6) The distance between any inductive sensors should be greater than 3m.
- 7) Do not place the sensor close to high-density objects such as metal, glass, concrete walls, etc, false triggering could happen. When the sensor is installed in a metal lamp, metal reflective surface, or a narrow enclosed environment, the microwave will be reflected repeatedly and cause false triggering. Please reduce the sensitivity or contact the manufacturer for technical support.
- 8) Please ensure that there are no moving signals around the sensor, such as fan, DC motor, sewer pipe, air outlet, etc., the sensor may generate false trigger.
- 9) You are advised to test 5 samples before mass application of sensor in a new lighting project.
- 10) Due to continuous improvement, the contents of this instruction could be changed without prior notice.
- 11) If the sensor is built under metal board, make sure the sensor surface should be seamless close to the metal plate without space.

