

SATURN 80 P-Z, W

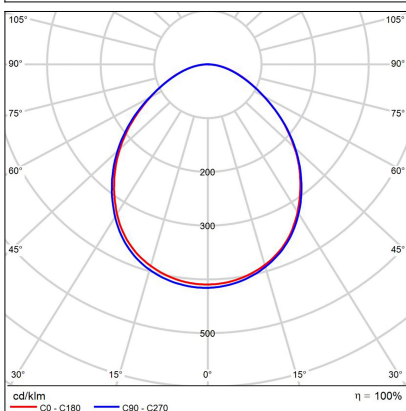
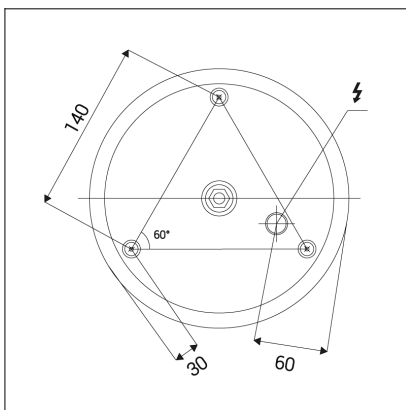
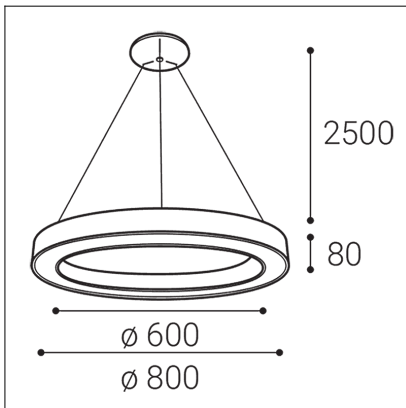

Code: 3270841

Color: WHITE / 9003

Material: ALUMINIUM/PMMA

Power: 80W

Color temperature: 4000K

Lumen output: 4200lm

Efficacy: 53lm/W

Color rendering index: 90+

SDCM: < 3

Light beam angle: 160°

Light Source: LED

Dimmable: ON/OFF

LED lifetime: L80B20 50.000h

Driver: 2 x 1050 mA

Voltage / Frequency: 220-240V/50-60Hz

Dimensions luminaire: d800x80 mm

Product weight kg: 5,7 kg

Packing carton: 1

Length suspension: 1200 mm

Package dimensions: 875x860x150 mm

SK

Kruhové závesné svietidlo určené pre montáž do interiéru. Svetelný zdroj - SMD LED. Svietidlo je vyrobené z hliníka, opálový difúzor z PMMA. K dispozícii v 2 rôznych veľkostiach v čiernej a bielej farbe. Použitie - všeobecné osvetlenie určené pre obytné alebo komerčné priestory (jedáleň, obývacia izba, hosťovská izba, spálňa, vstupné priestory, kuchyňa, recepcia, rokovacie miestnosti).

CZ

Kruhové závesné svítidlo určeno pro montáž do interiéru. Světelný zdroj - SMD LED. Svítidlo je vyrobeno z hliníku, opálový difuzor z PMMA. K dispozici ve 2 různých velikostech v černé a bílé barvě. Použití - všeobecné osvětlení určeno pro obytné nebo komerční prostory (jídlna, obývací pokoj, pokoj pro hosty, ložnice, vstupní prostory, kuchyň, recepce, jednací místnosti).

EN

Round hanging lamp intended for installation in the interior. Light source - SMD LED. The lamp is made of aluminum, the opal diffuser is made of PMMA. Available in 2 different sizes in black and white. Use - general lighting intended for residential or commercial spaces (dining room, living room, guest room, bedroom, entrance area, kitchen, reception, meeting rooms).

DE

Runde Hängelampe für die Installation im Innenraum. Lichtquelle - SMD-LED. Die Leuchte besteht aus Aluminium, der opale Diffusor aus PMMA. Erhältlich in 2 verschiedenen Größen in schwarz und weiß. Verwenden - Allgemeinbeleuchtung für Wohn- oder Gewerberäume (Esszimmer, Wohnzimmer, Gästezimmer, Schlafzimmer, Eingangsbereich, Küche, Rezeption, Besprechungsräume).

